

## FEATURES

- 1 transmitter and 1 receivers of the serial data of the standard RS-485
- Auto Shutdown function provide low power consumption
- Supply voltage range: 5.0V±5%
- Operating temperature range: -40 ~ +85°C
- ESD protection up to 2000V for transmitter input and receiver output (TTL/CMOS levels) and up to 15000V for transmitter output and receiver input (RS-485 levels)
- Latch current, min – 300mA at normal climatic condition
- Enhanced ESD Specifications:
  - ±15kV IEC61000-4-2 Air Discharge
  - ±8kV IEC61000-4-2 Contact Discharge

## GENERAL DESCRIPTION

The CBM3085A is interface transceiver of serial data under RS-485 standard with low power consumption.

The CBM3085A is purposed for application in telecom systems under RS-485/RS-422 standards with low power dissipation, translators of the level, transceiving devices sensitive to electromagnetic radiation, industrial control systems.

## Pin Description

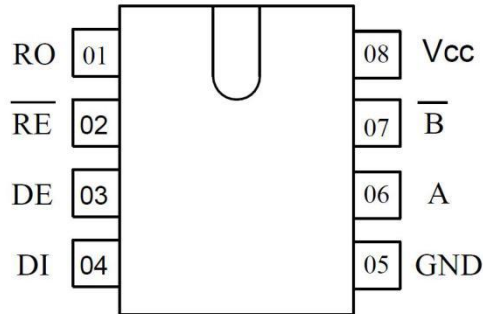

Figure 2

## Pin Description

Pin Number	Symbol	Pin Description
01	RO	TTL/CMOS Receiver data output
02	RE	Receiver Output Enable.
03	DE	Transmitter Output Enable.
04	DI	Transmitter input
05	GND	Common pin
06	A	Noninverting receiver/transmitter input/output
07	B	Inverting receiver/transmitter input/output
08	VCC	Power supply

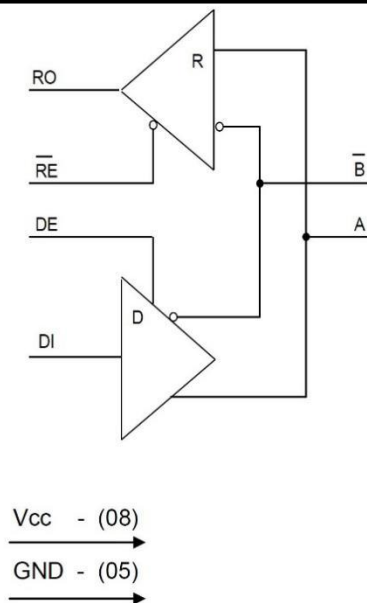

Figure 3. Block Diagram

### Transmitter Truth Table

INPUTS			OUTPUTS	
RE	DE	DI	B	A
X	H	H	L	H
X	H	L	H	L
L	L	X	Z	Z
H	L	X	ZZ	

Note : H – high level, L – low level , X –don’ t care, Z – third state

### Receiver Truth Table

INPUTS			OUTPUTS
RE	DE	A,B	RO
L	X	$\geq -0,05 B$	H
L	X	$\leq -0,2 B$	L
L	X	BH	H
H	H	X	Z
H	L	X	ZZ

**Note** : H – high level, L – low level , BH – inputs not used, X –don’ t care, Z – third state, ZZ – inputs and outputs are in the third state

### Recommended Operating Condition

Symbol	Parameter	Limit		Unit
		min	max	
V <sub>CC</sub>	Supply voltage	4.75	5.25	V
V <sub>IL</sub>	Input low voltage DI, DE, PE pins	0	0.8	V
V <sub>IH</sub>	Input high voltage DI, DE, PE pins	2.0	VCC	V
V <sub>OD</sub>	Transmitter output voltage	-7.0	12.0	V
V <sub>IR</sub>	Receiver input voltage	-7.0	12.0	V
V <sub>OR</sub>	Receiver output voltage	0	VCC	V
V <sub>TH</sub>	Receiver differential threshold voltage	±50	±200	V
T	Ambient temperature	-40	80	°C

## Maximum Ratings

Symbol	Parameter	Limit		Unit
		min	max	
V <sub>CC</sub>	Supply voltage	-	7.0	V
V <sub>IL</sub>	Input voltage on pins DI, DE,RE	-0.3	7.0	V
V <sub>OD</sub>	Transmitter output voltage	-13	13	V
V <sub>IR</sub>	Receiver input voltage	-13	13	V
V <sub>OR</sub>	Receiver output voltage	-0.3	V <sub>CC</sub> +0.3	V

\*Stresses beyond those listed under “maximum ratings” may cause permanent damage to the device.

These are stress ratings only and functional operation of the device at these or any other conditions beyond those indicated under “recommended operating conditions” is not implied.

Exposure to absolute-maximum-rated conditions for extended periods may affect device reliability.

## Electrical Parameters

( $V_{CC} = 5V \pm 5\%$ )

Symbol	Parameter	Mode	Limit		$T_A, ^\circ\text{C}$	Unit
			Min	Max		
$I_{CC}$	Idle mode supply current	$V_{RE} = 0B$ or $V_{CC}$ $V_{DI} = 0B$ or $V_{CC}$ $V_{DE} = V_{CC}$	-	800	$25 \pm 10$	$\mu\text{A}$
		900		$-40; 85$		
		$V_{RE} = 0\text{ V}$ $V_{DI} = 0\text{ V}$ or $V_{CC}$ $V_{DE} = 0$	-	500	$25 \pm 10$	
		600		$-40; 85$		
$I_{SHDN}$	Shutdown mode supply current	$V_{DE} = 0\text{V}$ $V_{RE} = V_{CC}$	-	9.0	$25 \pm 10$	$\mu\text{A}$
		10		$-40; 85$		
$I_{ILL}$	Input low leakage current on control pin	$V_{DE} = V_{DI} = V_{RE} = 0\text{V}$	-	-0.2	$25 \pm 10$	$\mu\text{A}$
				-2.0	$-40; 85$	
$I_{ILH}$	Input high leakage current on control pin	$V_{DE} = V_{DI} = V_{RE} = V_{CC}$	-	0.2	$25 \pm 10$	$\mu\text{A}$
				2.0	$-40; 85$	
$t_{SHDN}$	Shutdown time	-	50	600	$25 \pm 10$	ns
<b>Receiver</b>						
$V_{OLR}$	Output low voltage	$V_{ID} = -200\text{mV}$ $I_{OL} = 4.0\text{ mA}$	-	0.36	$25 \pm 10$	V
				0.4	$-40; 85$	
$V_{OHR}$	Output high voltage	$V_{ID} = -50\text{ mV}$ $I_{OH} = -4.0\text{ mA}$	$V_{CC} - 1.5$	-	$25 \pm 10$	V
					$-40; 85$	
$R_i$	Input resistance	$-7.0\text{ V} \leq V_{IR} \leq 12\text{ V}$	96	-	$25 \pm 10$	$\text{k}\Omega$
					$-40; 85$	
$I_i$	Input current	$V_{DE} = 0\text{ V}$ $V_{CC} = 0$ or $5.25\text{ V}$	-	114	$25 \pm 10$	$\mu\text{A}$
				-66		
				125	$-40; 85$	
				-75		
$I_{OZLR}$	Output low current for OFF-state	$V_{OR} = 0.4\text{ V}$	-	-0.5	$25 \pm 10$	$\mu\text{A}$
				-1.0	$-40; 85$	
$I_{OZHR}$	Output high current for OFF-state	$V_{OR} = 2.4\text{ V}$	-	0.5	$25 \pm 10$	$\mu\text{A}$
				1.0	$-40; 85$	

$I_{OSHR}$	Output high short circuit current	$V_{OR} = V_{CC}$	8.0	87	$25 \pm 10$	mA
			7.0	95	-40; 85	
$I_{OSLR}$	Output low short circuit current	$V_{OR} = 0V$	-8.0	-87	$25 \pm 10$	mA
			-7.0	-95	-40; 85	
$V_{hR}$	Hysteresis	-	-	50	$25 \pm 10$	mV
$t_{PHLR}$ , $t_{PLHR}$	Receiver input to output switching delay	$ V_{ID}  \geq 2.0V$ $t_{LH} = t_{HL} \leq 15$ ns	-	185	$25 \pm 10$	ns
				200	-40; 85	
$t_{SKDR}$	Differential receiver skew	$ V_{ID}  \geq 2.0V$ $t_{LH} = t_{HL} \leq 15$ ns	-	28	$25 \pm 10$	ns
				30	-40; 85	
$t_{PZHR}$ , $t_{PZLR}$	Receiver enable from OFF to output high (low)	$C_L = 100$ pF	-	45	$25 \pm 10$	ns
				50	-40; 85	
$t_{LR(SHDN)}$ , $t_{HR(SHDN)}$	Receiver enable from shutdown to output high (low)	$C_L = 100$ pF	-	3150	$25 \pm 10$	ns
				3500	-40; 85	
<b>Transmitter</b>						
$V_{OD1}$	Differential output voltage (no load)	-	5.0	-	$25 \pm 10$ -40; 85	V
$V_{OD2}$	Differential output voltage (no load)	$R_L = 50\Omega$ (RS-422)	2.08	-	$25 \pm 10$ -40; 85	V
			2.00	-	-40; 85	
		$R_L = 27\Omega$ (RS-485)	1.56	-	$25 \pm 10$ -40; 85	
			1.50	-	-40; 85	
$\Delta V_{OD}$	Change in magnitude of differential output voltage for complementary output states	$R_L = 50; 27\Omega$	-	0.18	$25 \pm 10$ -40; 85	V
				0.2	-40; 85	
$V_{OC}$	Output bias voltage refer to common pin	$R_L = 50; 27\Omega$	-	2.9	$25 \pm 10$ -40; 85	V
				3.0	-40; 85	
$\Delta V_{OC}$	Change in magnitude of bias output voltage for complementary output states	$R_L = 50; 27\Omega$	-	0.18	$25 \pm 10$ -40; 85	V
				0.20	-40; 85	
$I_{OSD}$	Short circuit current	$-7.0V \leq V_{OD} \leq V_{CC}$	-	$\pm 240$	$25 \pm 10$ -40; 85	
					$\pm 250$	
		$0V \leq V_{OD} \leq 12V$		240	$25 \pm 10$ -40; 85	
				250	-40; 85	
		$0V \leq V_{OD} \leq V_{CC}$		$\pm 26$	$25 \pm 10$ -40; 85	
			$\pm 25$	-40; 85		
$V_{hD}$	Hysteresis	-	-	200	$25 \pm 10$	
$t_{PHLD}$ , $t_{PLHD}$	Transmitter input to output switching delay	$C_{L1} = C_{L2} = 100$ pF $R_{DIFF} = 54\Omega$	330	800	$25 \pm 10$	
			250	1000	-40; 85	

$t_{\text{SKEW D}}$	Transmitter output skew	$C_{L1} = C_{L2} = 100 \text{ pF}$ $R_{\text{DIFF}} = 54\Omega$		90	$25 \pm 10$	
				100	-40; 85	
$t_{\text{PZH D}},$ $t_{\text{PZL D}}$	Transmitter enable time from OFF to output high (low)	$C_L = 100 \text{ pF}$		2200	$25 \pm 10$	
				2500	-40; 85	
$t_{\text{PHZ D}},$ $t_{\text{PLZ D}}$	Transmitter disable time from output high (low) to OFF	$C_L = 15 \text{ pF}$		90	$25 \pm 10$	
				100	-40; 85	
$t_{\text{RD}}, t_{\text{FD}}$	Rise or fall time of differential output signal	$R_{\text{DIFF}} = 54\Omega$ $C_{L1} = C_{L2} = 100 \text{ pF}$	220	620	$25 \pm 10$	
			200	750	-40; 85	
$t_{\text{LD (SHDN)},}$ $t_{\text{HD (SHDN)}}$	Transmitter enable time from shutdown to output high (low)	$C_L = 15 \text{ pF}$		4000	$25 \pm 10$	
				4500	-40; 85	
ST	Data rate		600		$25 \pm 10$	
			500		-40; 85	

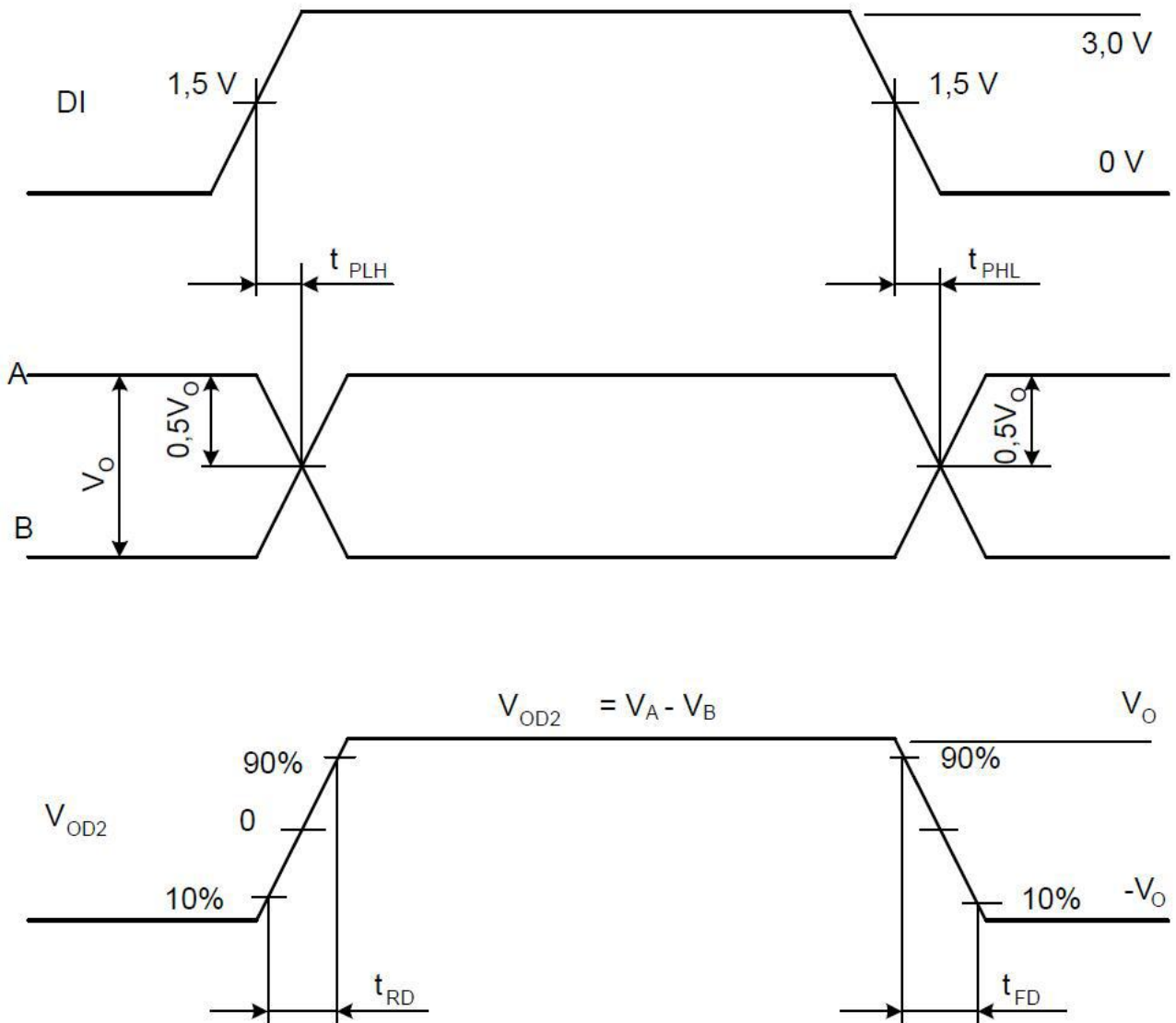
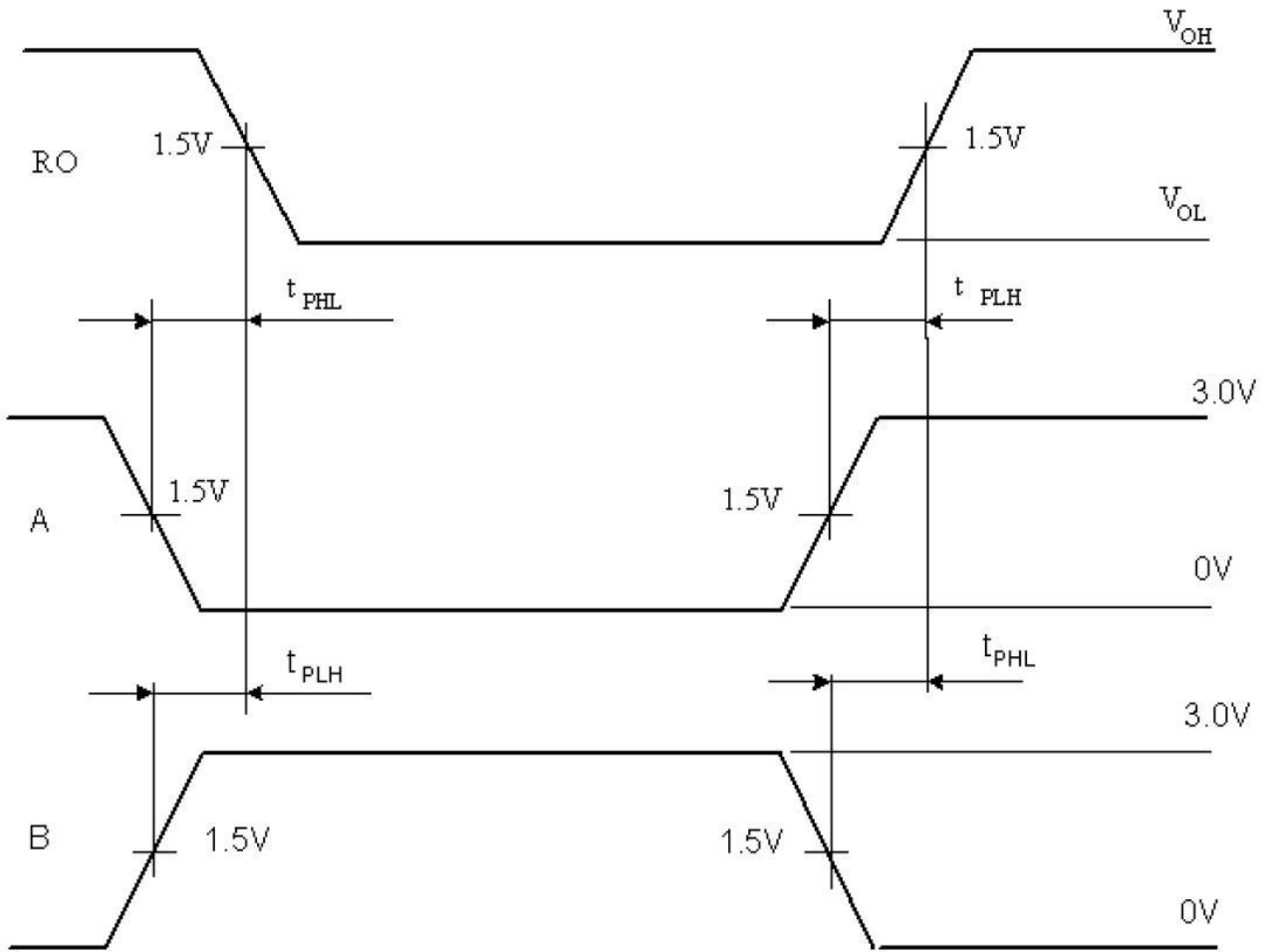

Figure 4. Transmitter output & input signals time diagram





During the input signal A is changing DC voltage 1.5 V is supplied to input B  
 During the input signal B is changing DC voltage 1.5 V is supplied to input A

Figure 5. Receiver output & input signals time diagram

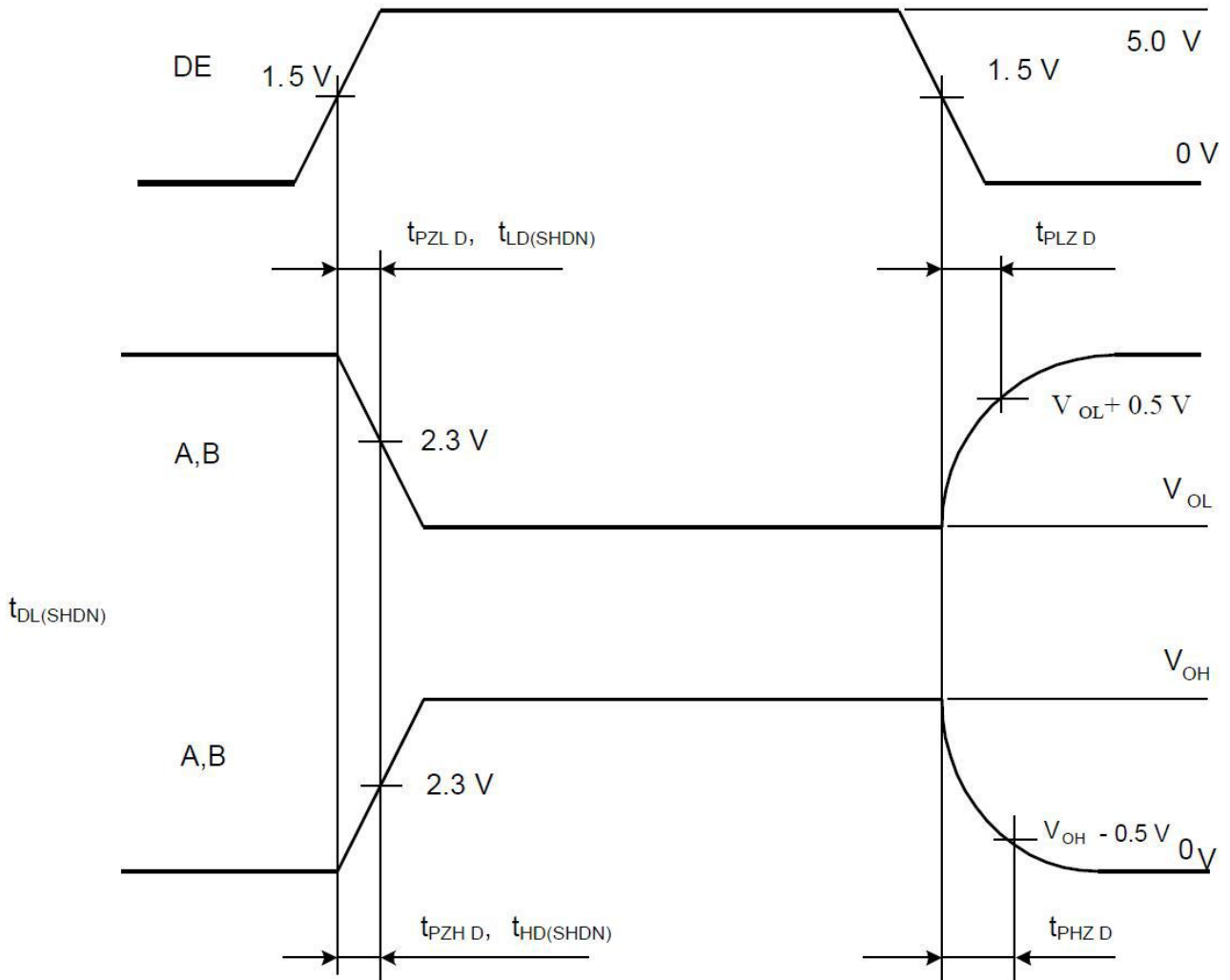

Figure 6. Transmitter output & input signals time diagram

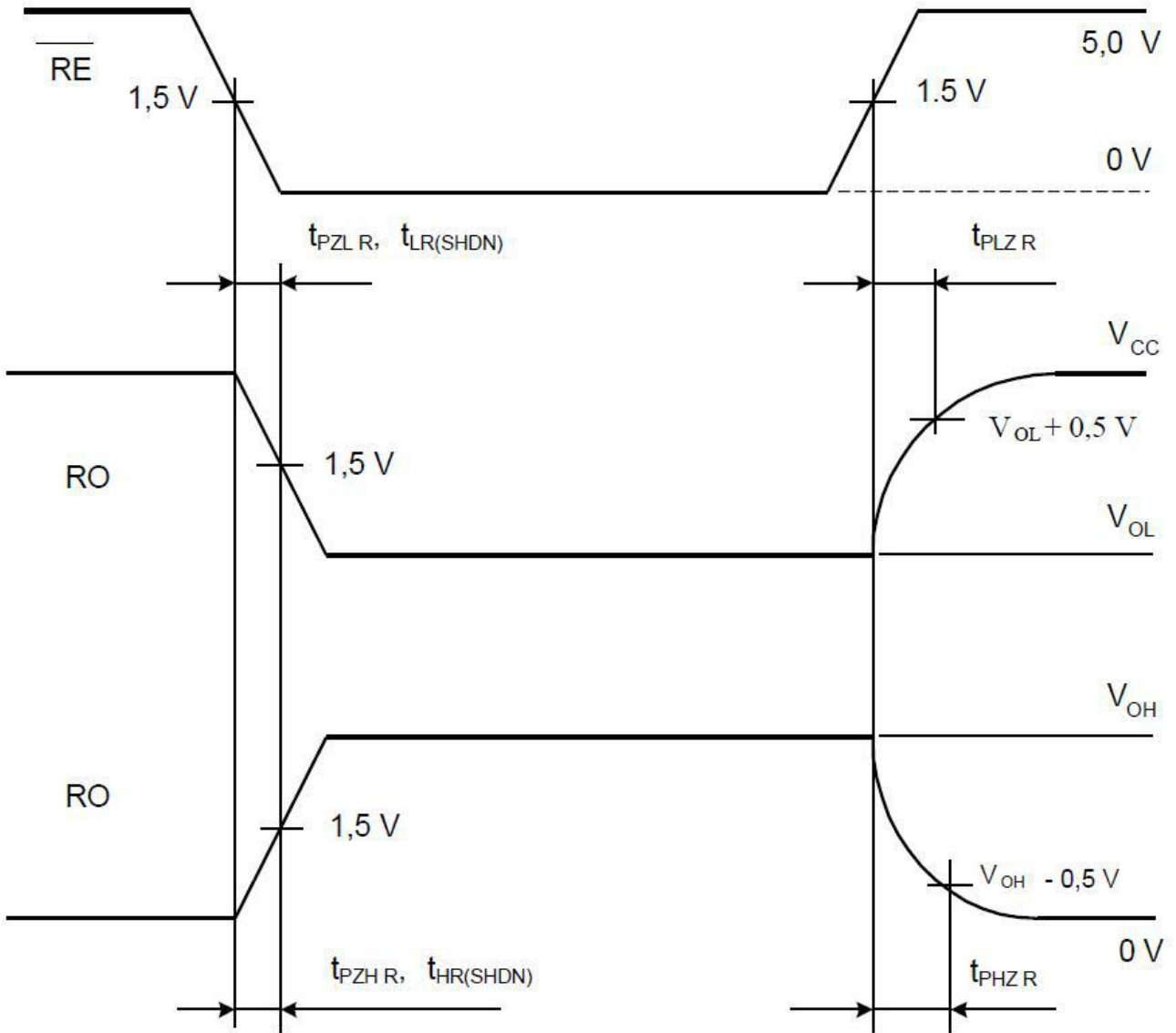
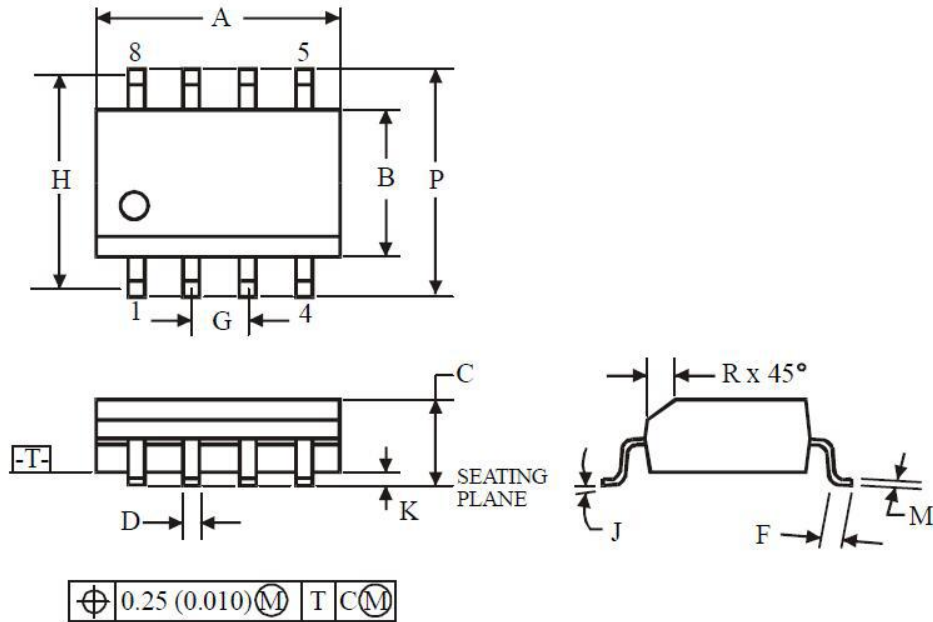

Figure 7. Receiver output & input signals time diagram

## PACKAGE



- NOTES:**
- Dimensions A and B do not include mold flash or protrusion.
  - Maximum mold flash or protrusion 0.15 mm (0.006) per side for A; for B - 0.25 mm (0.010) per side.

Symbol	Dimensions ,mm	
	Min	Max
A	4.8	5
B	3.8	4
C	1.35	1.75
D	0.33	0.51
F	0.4	1.27
G	1.27	
H	5.72	
J	0°	8°
K	0.1	0.25
M	0.19	0.25
P	5.8	6.2
R	0.25	0.5

## PACKAGE/ORDERING INFORMATION

PRODUCT	ORDERING NUMBER	TEMPRANGE	PACKAGE	PAKEAGE MARKING	TRANSPOT MEDIA,QUANTILY
CBM3085A	CBM3085AS8	-40°C~125°C	SOIC-8(SOP8)	CBM3085AS	Tape and Reel,2500
	CBM3085ACS8	-0°C~70°C	SOIC-8(SOP8)	CBM3085AC	Tape and Reel,2500